

SPECIALIZED BATTERY TOOL RIT-TOOL E-FORCE3

E FORCE 3

Part no.
1093377

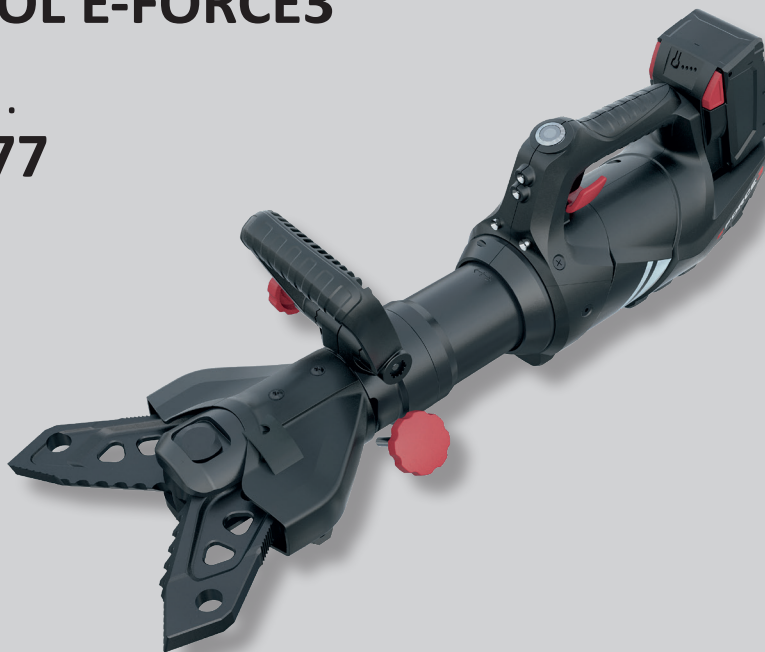

Technical data:

Spreading width	215 mm
Weight (ready for use)	13,3 kg
Dimensions (LxWxH)	773 x 192 x 241 mm
Nominal pressure	700 bar
DIN class	C100-H-E-I
EN class (EN 13204)*	AC140H-13,3
EN cutting class (EN 13204)*	1H-2H-3H-4H-5H
NFPA class (NFPA 1936)	A6-B7-C6-D7-E7-F3

Door opener tip
ID 1096859

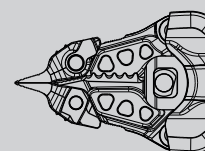

Standard tip
ID 1050616

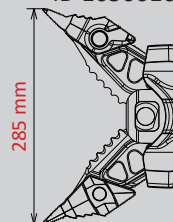

Special tip
ID 1051896

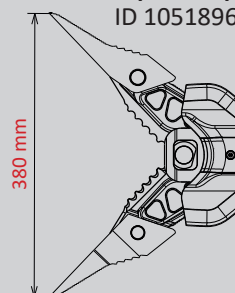

Pulling adapter
ID 2836033

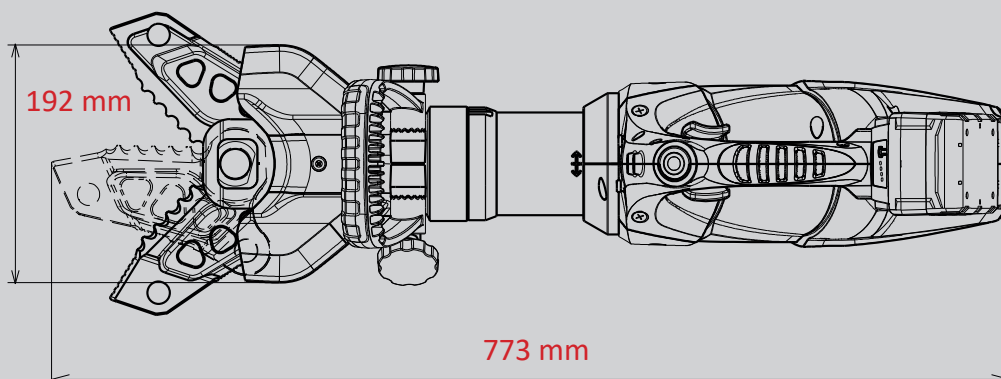
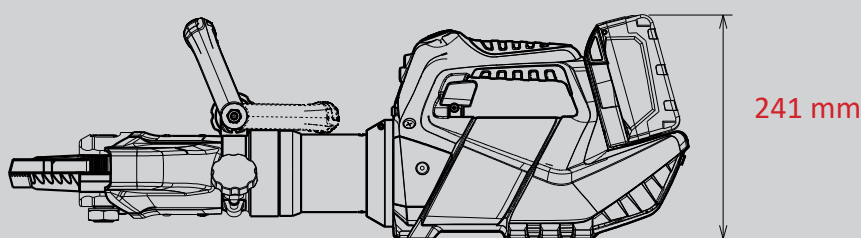
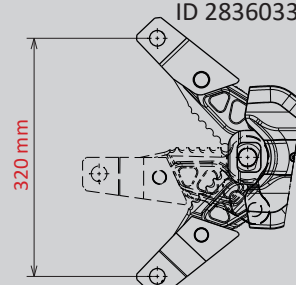

* According to EN 13204. Images are non-binding. We reserve the right to technical modifications.
08/2022A