







Cizalla RSC 190 PLUS

N° de piezas
1101569



-  **FORGED**
-  **360° HANDLE**
-  **PLUS**
-  **SINGLE**
-  **X-CHANGE**
-  **PUSH CONTROL**

Datos técnicos:

Apertura	187 mm
Peso	17,8 kg
Dimensiones (LxAnxAI)	758 x 236 x 164
Presión nominal	700 bar
Clasificación EN (EN 13204)	BC187K-17,8
Rendimiento de corte EN (EN 13204)	1K-2K-3K-4K-5K
Clase de corte NFPA (NFPA 1936)	A8-B9-C7-D9-E9-F4

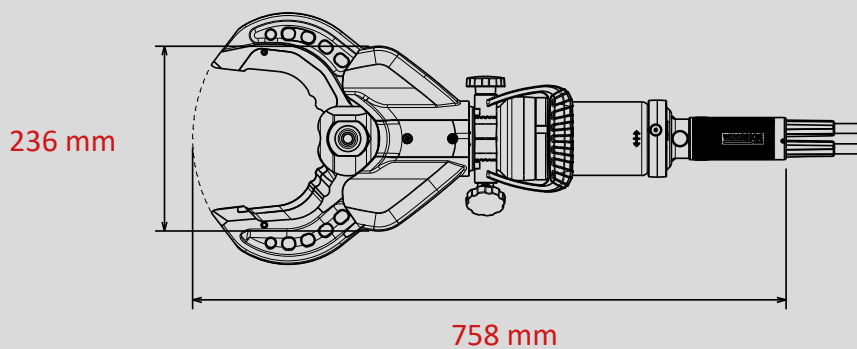
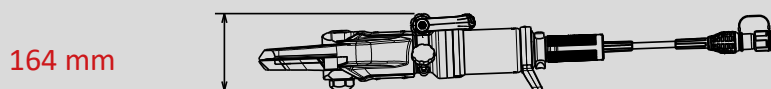

WEBER-HYDRAULIK GMBH
Heilbronner Straße 30
74363 Güglingen, Germany
Phone +49 7135 71-10270
info@weber-rescue.com

Emil Weber Platz 1
4460 Losenstein, Austria
Phone +43 7255 6237-120

Las ilustraciones únicamente son indicativas. Reservado el derecho a introducir modificaciones técnicas.
2022A, 05/2022