







Cisaille RSC 190 PLUS

Référence
1101569



-  **FORGED**
-  **360° HANDLE**
-  **PLUS**
-  **SINGLE**
-  **X-CHANGE**
-  **PUSH CONTROL**

Caractéristiques techniques :

Largeur d'ouverture	187 mm
Poids	17,8 kg
Dimensions (LxlxH)	758 x 236 x 164
Pression nominale	700 bar
Classification EN (DIN EN 13204)	BC187K-17,8
Puissance de coupe EN (EN 13204)	1K-2K-3K-4K-5K
Classification NFPA (NFPA 1936)	A8-B9-C7-D9-E9-F4

164 mm

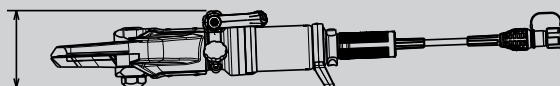

236 mm

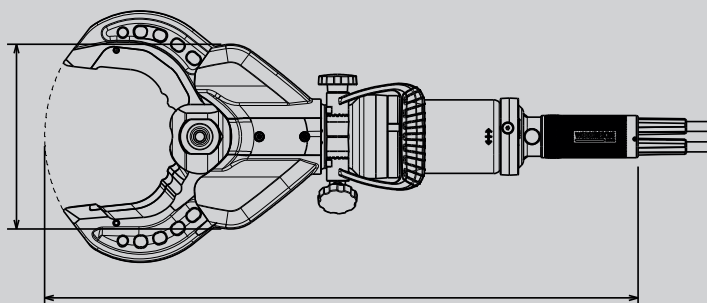

758 mm

WEBER-HYDRAULIK GMBH
Heilbronner Straße 30
74363 Güglingen, Germany
Phone +49 7135 71-10270
info@weber-rescue.com

Emil Weber Platz 1
4460 Losenstein, Austria
Phone +43 7255 6237-120

Images non contractuelles. Toutes modifications techniques réservées.
2022A, 05/2022