







Cisaille RSC 200 PLUS

Référence
1105445



-  SMOOTH CUT
-  FORGED
-  360° HANDLE
-  PLUS
-  SINGLE
-  X-CHANGE
-  PUSH CONTROL

Caractéristiques techniques :

Largeur d'ouverture	202 mm
Poids	22,3 kg
Dimensions (LxlxH)	828 x 296 x 181 mm
Pression nominale	700 bar
Classification EN (DIN EN 13204)	CC202K-22,3
Puissance de coupe EN (EN 13204)	1K-2K-3K-4K-5K
Classification NFPA (NFPA 1936)	A9-B9-C9-D9-E9-F5

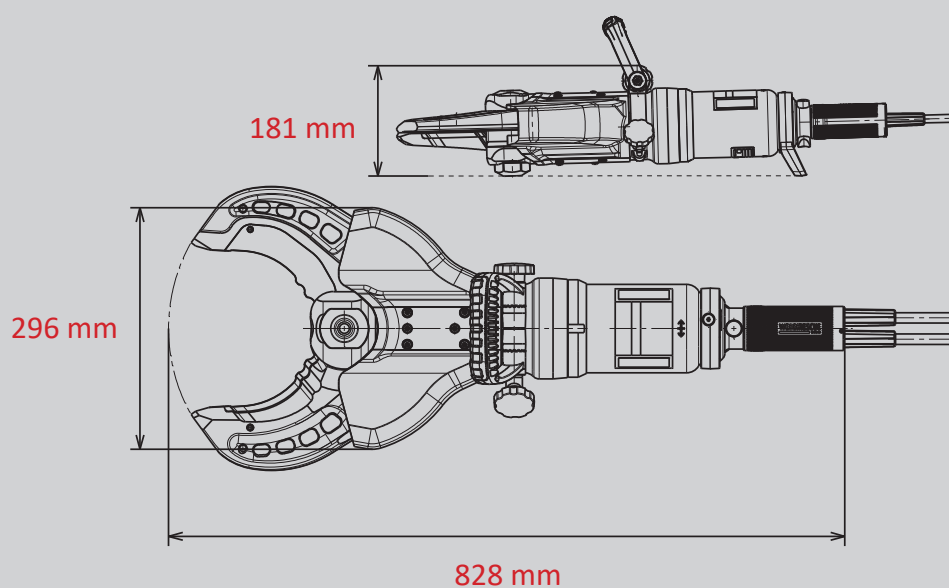

Images non contractuelles. Toutes modifications techniques réservées.
01/2025A