

Cutter RSC 200

Part no.
1098473



-  **FORGED**
-  **360° HANDLE**
-  **SINGLE**
-  **X-CHANGE**
-  **PUSH CONTROL**

Technical data:

Opening width	200 mm
Weight (ready to use)	20,9 kg
Oil needs	0,2 l
Dimensions (LxWxH)	827 x 300 x 177 mm
Nominal pressure	700 bar
EN cutting class (EN 13204)	CC201K-20,9
EN cutting performance (EN 13204)	1K-2K-3K-4K-5K
NFPA cutting class (NFPA 1936)	A9-B9-C9-D9-E9-F5

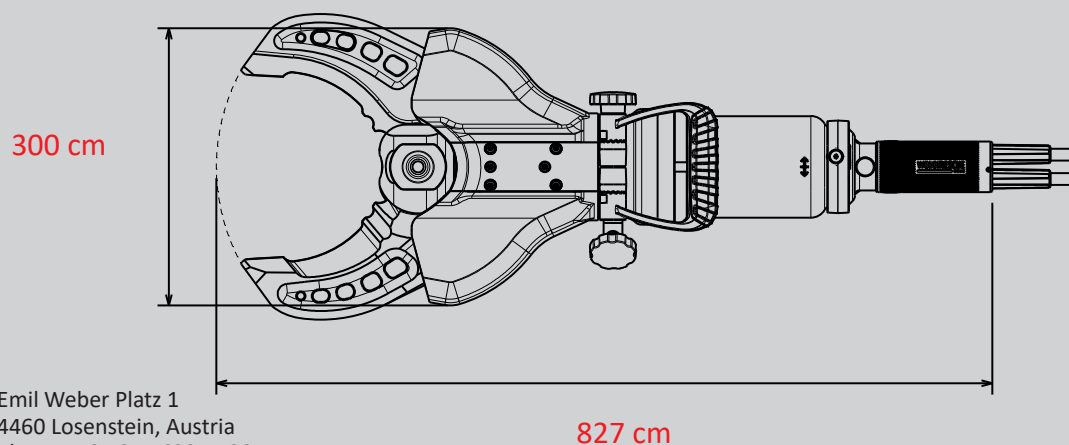
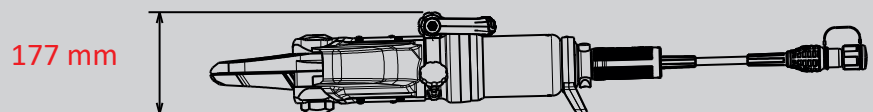

WEBER-HYDRAULIK GMBH
Heilbronner Straße 30
74363 Güglingen, Germany
Phone +49 7135 71-10270
info@weber-rescue.com

Emil Weber Platz 1
4460 Losenstein, Austria
Phone +43 7255 6237-120

Images are non-binding. We reserve the right to technical modifications.
2022A, 05/2022